

# CF COMPONENTS

## Aisi 304 CF blind flange

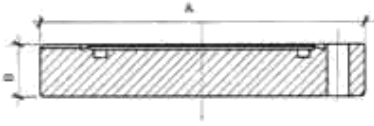

DN – KF	A	B	C	D	CODE
CF16	34	7,2	-	-	C001
CF25	54	13	-	-	C002
CF35/40	70	13	-	-	C003
CF50	86	18	-	-	C004
CF63	113	17,5	-	-	C005
CF75	117	19	-	-	C006
CF100	152	20	-	-	C007
CF125	171	21	-	-	C008
CF150	202	22,5	-	-	C009
CF200	253	24,5	-	-	C010
CF250	306	26	-	-	C011
CF275	336	28	-	-	C012
CF300	355	28	-	-	C013
CF350	419	28	-	-	C014

## Aisi 316 CF blind flange

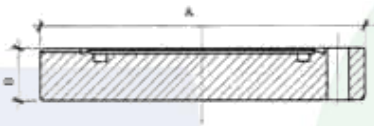

DN – KF	A	B	C	D	CODE
CF16	34	7,2	-	-	C015
CF25	54	13	-	-	C016
CF35/40	70	13	-	-	C017
CF50	86	18	-	-	C018
CF63	113	17,5	-	-	C019
CF75	117	19	-	-	C020
CF100	152	20	-	-	C021
CF125	171	21	-	-	C022
CF150	202	22,5	-	-	C023
CF200	253	24,5	-	-	C024
CF250	306	26	-	-	C025
CF275	336	28	-	-	C026
CF300	355	28	-	-	C027
CF350	419	28	-	-	C028

## CF COMPONENTS

### Aisi 304 CF soldering flange

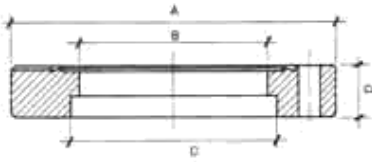

DN – KF	A	B	C	D	CODE
CF16	34	16	18	7,2	C029
CF25	54	21	25,4	13	C030
CF35	70	35	38	13	C031
CF38	70	38	42,4	13	C032
CF40	70	40,5	44,5	13	C033
CF50	85	48	50,8	17,5	C034
CF63	113	63	70,5	17,5	C035
CF75	117	72	76,5	19	C036
CF100	152	98	102	20	C037
CF100	152	100	104,5	20	C038
CF100	152	100	108	20	C039
CF125	171	123,7	127,3	21	C040
CF150	202	150	154,5	22,5	C041
CF200	253	200	204,5	24,5	C042
CF200	253	200	206,5	24,5	C043
CF250	306	250	254,5	26	C044
CF250	306	250	256,3	26	C045
CF275	336	267	273,5	28	C046
CF300	355	300	305,5	28	C047
CF350	419	350	356,5	28	C048

# CF COMPONENTS

## Aisi 316 CF soldering flange

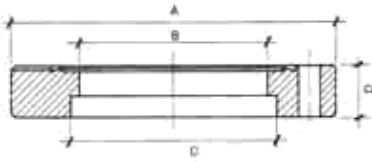

DN – KF	A	B	C	D	CODE
CF16	34	16	18	7,2	C049
CF25	54	21	25,4	13	C050
CF35	70	35	38	13	C051
CF38	70	38	42,4	13	C052
CF40	70	40,5	44,5	13	C053
CF50	85	48	50,8	17,5	C054
CF63	113	63	70,5	17,5	C055
CF75	117	72	76,5	19	C056
CF100	152	98	102	20	C057
CF100	152	100	104,5	20	C058
CF100	152	100	108	20	C059
CF125	171	123,7	127,3	21	C060
CF150	202	150	154,5	22,5	C061
CF200	253	200	204,5	24,5	C062
CF200	253	200	206,5	24,5	C063
CF250	306	250	254,5	26	C064
CF250	306	250	256,3	26	C065
CF275	336	267	273,5	28	C066
CF300	355	300	305,3	28	C067
CF350	419	350	356,5	28	C068

## CF COMPONENTS

### Aisi 304 soldering revolving flange



DN - KF	A	B	C	D	CODE
CF16	34	18	7,2	-	C069
CF25	54	25,4	13	-	C070
CF35	70	38	13	-	C071
CF38	70	42,4	13	-	C072
CF40	70	44,5	13	-	C073
CF50	85	50,8	17,5	-	C074
CF63	113	70,5	17,5	-	C075
CF75	117	76,5	19	-	C076
CF100	152	102	20	-	C077
CF100	152	104,5	20	-	C078
CF100	152	108	20	-	C079
CF125	171	127,3	21	-	C080
CF150	202	154,5	22,5	-	C081
CF200	253	204,5	24,5	-	C082
CF250	306	254,5	26	-	C083
CF275	336	273,5	28	-	C084
CF300	355	305,3	28	-	C085
CF350	419	356,5	28	-	C086

# CF COMPONENTS

## Aisi 316 CF soldering revolving flange

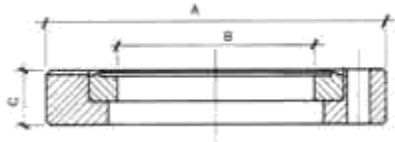

DN - KF	A	B	C	D	CODE
CF16	34	18	7,2	-	C087
CF25	54	25,4	13	-	C088
CF35	70	38	13	-	C089
CF38	70	42,5	13	-	C090
CF40	70	44,5	13	-	C091
CF50	85	50,8	17,5	-	C092
CF63	113	70,5	17,5	-	C093
CF75	117	76,5	19	-	C094
CF100	152	102	20	-	C095
CF100	152	104,5	20	-	C096
CF100	152	108	20	-	C097
CF125	171	127,3	21	-	C098
CF150	202	154,5	22,5	-	C099
CF200	253	204,5	24,5	-	C100
CF250	306	254,5	26	-	C101
CF275	336	273,5	28	-	C102
CF300	355	305,3	28	-	C103
CF350	419	356,5	28	-	C104

## Aisi 304 CF blind revolving flange

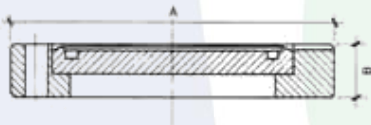

DN - KF	A	B	C	D	CODE
CF16	34	7,2	-	-	C105
CF25	54	13	-	-	C106
CF35/40	70	13	-	-	C107
CF50	85	17,5	-	-	C108
CF63	113	17,5	-	-	C109
CF75	117	19	-	-	C110
CF100	152	20	-	-	C111
CF125	171	21	-	-	C112
CF150	202	22	-	-	C113
CF200	253	24,5	-	-	C114
CF250	306	26	-	-	C115
CF275	336	28	-	-	C116
CF300	355	28	-	-	C117
CF350	419	28	-	-	C118

# CF COMPONENTS

## Aisi 316 CF blind revolving flange

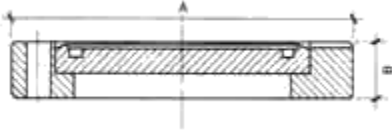

DN - KF	A	B	C	D	CODE
CF16	34	7,2	-	-	C119
CF25	54	13	-	-	C120
CF35/40	70	13	-	-	C121
CF50	85	17,5	-	-	C122
CF63	113	17,5	-	-	C123
CF75	117	19	-	-	C124
CF100	152	20	-	-	C125
CF125	171	21	-	-	C126
CF150	202	22	-	-	C127
CF200	253	24,5	-	-	C128
CF250	306	26	-	-	C129
CF275	336	28	-	-	C130
CF300	355	28	-	-	C131
CF350	419	28	-	-	C132

## Aisi 304 CF flange with tube

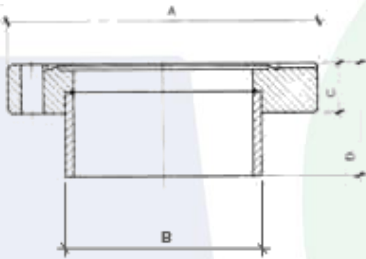

DN - KF	A	B	C	D	CODE
CF16	34	18	7,2	35	C133
CF25	54	25	13	60	C134
CF35	70	38	13	60	C135
CF38	70	42,4	13	60	C136
CF40	70	44,5	13	60	C137
CF50	85	50,8	17,5	80	C138
CF63	113	70	17,5	80	C139
CF75	117	76	19	90	C140
CF100	152	104	20	90	C141
CF125	171	127	21	90	C142
CF150	202	154	22,5	100	C143
CF200	253	204,5	24,5	120	C144
CF250	306	256	26	150	C145
CF275	336	273	28	200	C146
CF300	355	305	28	250	C147
CF350	419	356	28	250	C148

# CF COMPONENTS

## Aisi 304 CF revolving flange with tube

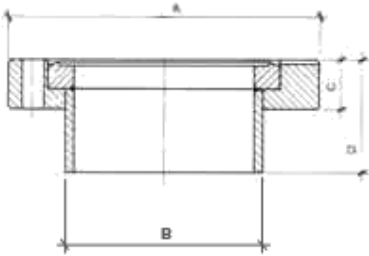

DN - KF	A	B	C	D	CODE
CF16	34	18	7,2	35	C149
CF25	54	25	13	60	C150
CF35	70	38	13	60	C151
CF38	70	42,4	13	60	C152
CF40	70	44,5	13	60	C153
CF50	85	48	17,5	80	C154
CF63	113	70	17,5	80	C155
CF75	117	76	19	90	C156
CF100	152	104	20	90	C157
CF125	171	127	21	90	C158
CF150	202	154	22,5	100	C159
CF200	253	204	24,5	120	C160
CF250	306	256	26	150	C161
CF275	336	273	28	200	C162
CF300	355	305	28	250	C163
CF350	419	356	28	250	C164

## Aisi 304 CF threaded blind flange

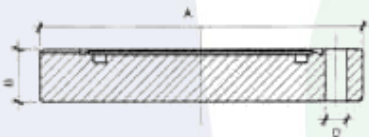

DN - KF	A	B	C	D	CODE
CF16	34	7,2	-	M4	C165
CF25	54	13	-	M6	C166
CF35/40	70	13	-	M6	C167
CF50	85	17,5	-	M6	C168
CF63	113	17,5	-	M8	C169
CF75	117	19	-	M8	C170
CF100	152	20	-	M8	C171
CF125	171	21	-	M8	C172
CF150	202	22,5	-	M8	C173
CF200	253	24,5	-	M8	C174
CF250	306	26	-	M8	C175
CF275	336	28	-	M10	C176
CF300	355	28	-	M10	C177
CF350	419	28	-	M10	C178

# CF COMPONENTS

## Aisi 316 CF threaded blind flange

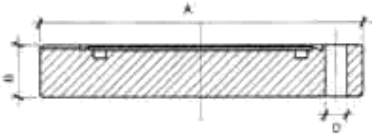

DN - KF	A	B	C	D	CODE
CF16	34	7,2	-	M4	C179
CF25	54	13	-	M6	C180
CF35/40	70	13	-	M6	C181
CF50	85	17,5	-	M6	C182
CF63	113	17,5	-	M8	C183
CF75	117	19	-	M8	C184
CF100	152	20	-	M8	C185
CF125	171	21	-	M8	C186
CF150	202	22,5	-	M8	C187
CF200	253	24,5	-	M8	C188
CF250	306	26	-	M8	C189
CF275	336	28	-	M10	C190
CF300	355	28	-	M10	C191
CF350	419	28	-	M10	C192

## Aisi 304 CF threaded soldering flange

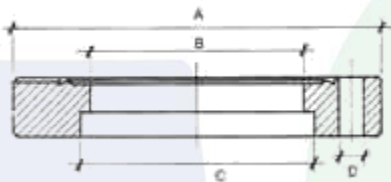

DN - KF	A	B	C	D	CODE
CF16	34	16	18,1	M4	C193
CF25	54	21	25,4	M6	C194
CF35	70	35	38	M6	C195
CF38	70	38	42,5	M6	C196
CF40	70	40	44,5	M6	C197
CF50	85	48	50,8	M6	C198
CF63	113	63	70,5	M8	C199
CF75	117	72	76,5	M8	C200
CF100	152	100	104,5	M8	C201
CF125	171	123,7	127,3	M8	C202
CF150	202	150	154,5	M8	C203
CF200	253	200	204,5	M8	C204
CF250	306	250	256,3	M8	C205
CF275	336	267	273,5	M10	C206
CF300	355	300	305,5	M10	C207
CF350	419	350	356,5	M10	C208

# CF COMPONENTS

## Aisi 316 CF threaded soldering flange

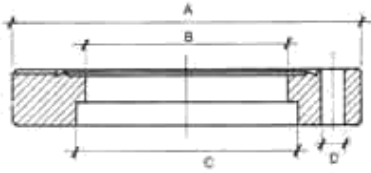

DN - KF	A	B	C	D	CODE
CF16	34	16	18,1	M4	C209
CF25	54	21	25,4	M6	C210
CF35	70	35	38	M6	C211
CF38	70	38	42,5	M6	C212
CF40	70	40	44,5	M6	C213
CF50	85	48	50,8	M6	C214
CF63	113	63	70,5	M8	C215
CF75	117	72	76,5	M8	C216
CF100	152	100	104,5	M8	C217
CF125	171	123,7	127,3	M8	C218
CF150	202	150	154,5	M8	C219
CF200	253	200	204,5	M8	C220
CF250	306	250	256,3	M8	C221
CF275	336	267	273,5	M10	C222
CF300	355	300	305,5	M10	C223
CF350	419	350	356,5	M10	C224

## Aisi 304 CF threaded revolving soldering flange



DN - KF	A	B	C	D	CODE
CF16	34	18	7,2	M4	C225
CF25	54	25,4	13	M6	C226
CF35	70	38	13	M6	C227
CF38	70	42,4	13	M6	C228
CF40	70	44,5	13	M6	C229
CF50	85	50,8	13	M6	C230
CF63	113	70,5	17,5	M8	C231
CF75	117	76,5	19	M8	C232
CF100	152	104,5	20	M8	C233
CF125	171	127,3	21	M8	C234
CF150	202	154,5	22,5	M8	C235
CF200	253	204,5	24,5	M8	C236
CF250	306	254,5	26	M8	C237
CF275	336	273,5	28	M10	C238
CF300	355	305,3	28	M10	C239
CF350	419	356,5	28	M10	C240

# CF COMPONENTS

## Aisi 316 CF threaded revolving soldering flange



DN - KF	A	B	C	D	CODE
CF16	34	18	7,2	M4	C241
CF25	54	25,4	13	M6	C242
CF35	70	38	13	M6	C243
CF38	70	42,4	13	M6	C244
CF40	70	44,5	13	M6	C245
CF50	85	50,8	13	M6	C246
CF63	113	70,5	17,5	M8	C247
CF75	117	76,5	19	M8	C248
CF100	152	104,5	20	M8	C249
CF125	171	127,3	21	M8	C250
CF150	202	154,5	22,5	M8	C251
CF200	253	204,5	24,5	M8	C252
CF250	306	254,5	26	M8	C253
CF275	336	273,5	28	M10	C254
CF300	355	305,3	28	M10	C255
CF350	419	356,5	28	M10	C256

## Aisi 304 CF threaded revolving blind flange

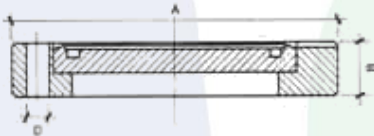

DN - KF	A	B	C	D	CODE
CF16	34	7,2	-	M4	C257
CF25	54	13	-	M6	C258
CF35/40	70	13	-	M6	C259
CF50	85	13	-	M6	C260
CF63	113	17,5	-	M8	C261
CF75	117	19	-	M8	C262
CF100	152	20	-	M8	C263
CF125	171	21	-	M8	C264
CF150	202	22	-	M8	C265
CF200	253	24,5	-	M8	C266
CF250	306	26	-	M8	C267
CF275	336	28	-	M10	C268
CF300	355	28	-	M10	C269
CF350	419	28	-	M10	C270

# CF COMPONENTS

## Aisi 316 CF threaded revolving blind flange

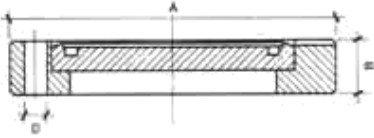

DN - KF	A	B	C	D	CODE
CF16	34	7,2	-	M4	C271
CF25	54	13	-	M6	C272
CF35/40	70	13	-	M6	C273
CF50	85	13	-	M6	C274
CF63	113	17,5	-	M8	C275
CF75	117	19	-	M8	C276
CF100	152	20	-	M8	C277
CF125	171	21	-	M8	C278
CF150	202	22	-	M8	C279
CF200	253	24,5	-	M8	C280
CF250	306	26	-	M8	C281
CF275	336	28	-	M10	C282
CF300	355	28	-	M10	C283
CF350	419	28	-	M10	C284

## Aisi 304 CF threaded flange with tube

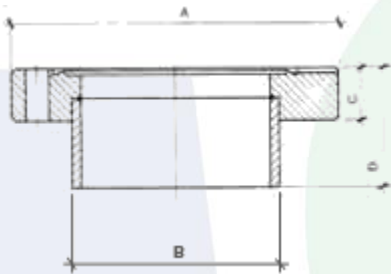

DN - KF	A	B	C	D	CODE
CF16	34	18	7,2	35	C285
CF25	54	25,4	13	60	C286
CF35	70	38	13	60	C287
CF38	70	42,4	13	60	C288
CF40	70	44,5	13	60	C289
CF50	85	50,8	13	80	C290
CF63	113	70,5	17,5	80	C291
CF75	117	76,5	19	90	C292
CF100	152	104,5	20	90	C293
CF125	171	127,3	21	90	C294
CF150	202	154,5	22,5	100	C295
CF200	253	205,3	24,5	120	C296
CF250	306	254,5	26	150	C297
CF275	336	273,5	28	250	C298
CF300	355	305,3	28	250	C299
CF350	419	356,5	28	250	C300

# CF COMPONENTS

## Aisi 304 CF threaded revolving flange with tube

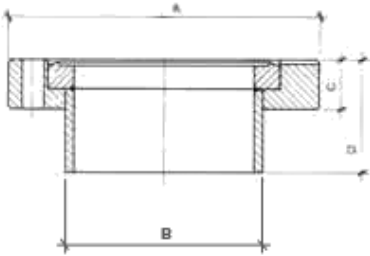

DN - KF	A	B	C	D	CODE
CF16	34	18	7,2	35	C301
CF25	54	25,4	13	60	C302
CF35	70	38	13	60	C303
CF38	70	42,4	13	60	C304
CF40	70	44,5	13	60	C305
CF50	85	50,8	13	80	C306
CF63	113	70,5	17,5	80	C307
CF75	117	76,5	19	90	C308
CF100	152	104,5	20	90	C309
CF125	171	127,5	21	90	C310
CF150	202	154,5	22,5	100	C311
CF200	253	205,3	24,5	120	C312
CF250	306	254,5	26	150	C313
CF275	336	273,5	28	250	C314
CF300	355	305,3	28	250	C315
CF350	419	356,5	28	250	C316

## Aisi 304 CF double face flange



DN - KF	A	B	C	D	CODE
CF16	34	16	7,2	-	C317
CF38	70	38	13	-	C318
CF63	113	63	17,5	-	C319
CF100	152	100	20	-	C320
CF150	202	150	22,5	-	C321
CF200	253	200	24,5	-	C322
CF250	306	250	26	-	C323

# CF COMPONENTS

## Aisi 304 CF zero level reduction

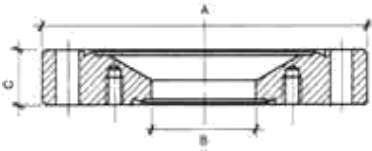

DN - KF	A	B	C	D	CODE
CF35/16	70	16	13	-	C324
CF63/38	113	16	17,5	-	C325
CF63/16	113	38	17,5	-	C326
CF100/38	152	38	20	-	C327
CF100/63	152	63	20	-	C328
CF150/35	202	35	22,5	-	C329
CF150/63	202	63	22,5	-	C330
CF150/100	202	100	22,5	-	C331
CF200/63	253	63	24,5	-	C332
CF200/100	253	100	24,5	-	C333
CF250/150	306	150	26	-	C334
CF300/200	356	200	28	-	C335

## Aisi 304 CF / KF adapter

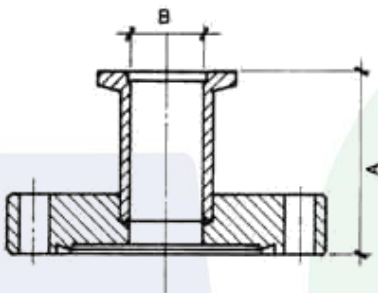

DN - KF	A	B	C	D	CODE
CF16/KF10	40	10	-	-	C336
CF16/KF16	40	16	-	-	C337
CF38/KF10	40	10	-	-	C338
CF38/KF16	40	16	-	-	C339
CF38/KF25	40	24	-	-	C340
CF38/KF40	60	41	-	-	C341
CF63/KF40	60	41	-	-	C342
CF63/KF50	60	50	-	-	C343
CF100/KF40	60	41	-	-	C344
CF100/KF50	60	50	-	-	C345

# CF COMPONENTS

## Aisi 304 CF / ISO adapter

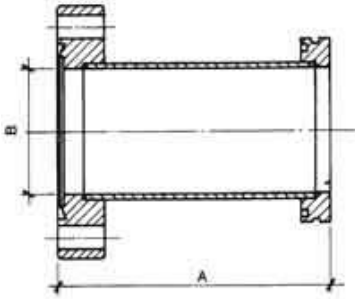

DN - KF	A	B	C	D	CODE
CF63/ISO63	100	70	-	-	C346
CF100/ISO100	100	102	-	-	C347
CF150/ISO160	100	153	-	-	C348
CF200/ISO150	100	150	-	-	C349
CF250/ISO200	100	200	-	-	C350

## Aisi 304 CF / CF reduction

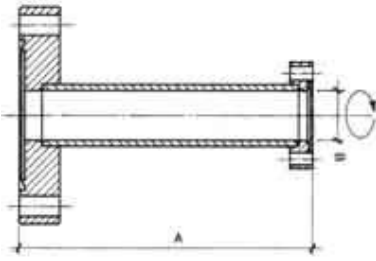

DN - KF	A	B	C	D	CODE
CF35/16	60	16	-	-	C351
CF63/25	95	25	-	-	C352
CF63/38	95	38	-	-	C353
CF100/38	110	38	-	-	C354
CF100/63	115	63	-	-	C355
CF150/100	120	100	-	-	C356
CF200/150	130	150	-	-	C357

## Aisi 304 CF straight junction

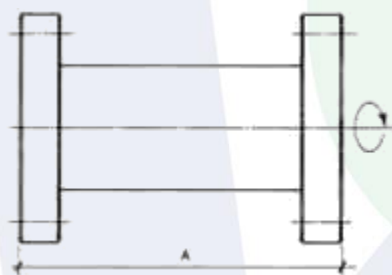

DN - KF	A	B	C	D	CODE
CF16	76	-	-	-	C358
CF38	126	-	-	-	C359
CF63	210	-	-	-	C360
CF100	270	-	-	-	C361
CF150	334	-	-	-	C362
CF200	420	-	-	-	C363
CF250		-	-	-	C364

# CF COMPONENTS

## Aisi 304 CF bellows

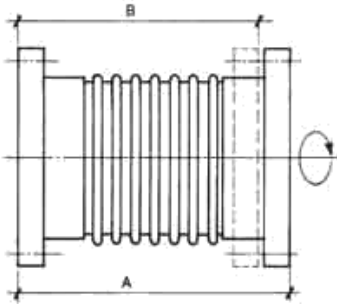

DN - KF	A	B	C	D	CODE
CF16	90	100	-	-	C365
CF38	120	130	-	-	C366
CF63	130	150	-	-	C367
CF100	130	150	-	-	C368
CF150	130	180	-	-	C369
CF200	230	250	-	-	C370
CF250	250	250	-	-	C371

## OFCH CF O-ring

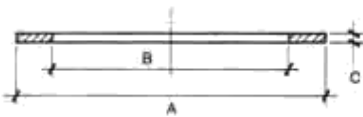

DN - KF	A	B	C	D	CODE
CF16	21,3	16	-	-	C372
CF25	32,8	25,6	-	-	C373
CF38/40	48,1	39	-	-	C374
CF50	61,6	50,8	-	-	C375
CF63	82,4	64	-	-	C376
CF75	120,5	76	-	-	C377
CF100	120,5	101,7	-	-	C378
CF125	141	127	-	-	C379
CF150	171,3	152,7	-	-	C380
CF200	222,1	203,3	-	-	C381
CF250	273	254	-	-	C382
CF275	294	275	-	-	C383
CF300	313	300	-	-	C384
CF350	356,5	376,5	-	-	C385

# CF COMPONENTS

## OFCH CF silver plated O-ring

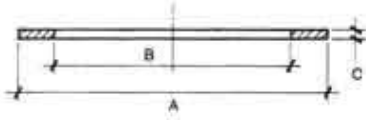

DN - KF	A	B	C	D	CODE
CF16	21,3	16	-	-	C386
CF25	32,8	25,6	-	-	C387
CF35/40	48,1	39	-	-	C388
CF50	61,6	50,8	-	-	C389
CF63	82,4	64	-	-	C390
CF75	120,5	76	-	-	C391
CF100	120,5	101,7	-	-	C392
CF125	141	127	-	-	C393
CF150	171,3	152,7	-	-	C394
CF200	222,1	203,3	-	-	C395
CF250	273	254	-	-	C396
CF275	294	275	-	-	C397
CF300	313	300	-	-	C398
CF350	356,5	376,5	-	-	C399

## VITON® O-ring

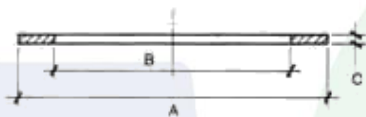

T. Max = 200°

DN - KF	A	B	C	D	CODE
CF16	21,3	16	-	-	C400
CF25	32,8	25,6	-	-	C401
CF35/40	48,1	39	-	-	C402
CF50	61,6	50,8	-	-	C403
CF63	82,4	64	-	-	C404
CF75	120,5	76	-	-	C405
CF100	120,5	101,7	-	-	C406
CF125	141	127	-	-	C407
CF150	171,3	152,7	-	-	C408
CF200	222,1	203,3	-	-	C409
CF250	273	254	-	-	C410
CF275	294	275	-	-	C411
CF300	313	300	-	-	C412
CF350	356,5	376,5	-	-	C413

# CF COMPONENTS

## Aisi 304 bolts set

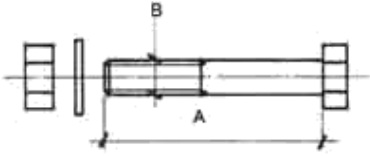

DN - KF	A	B	C	D	CODE
CF16	20	M4	N°6	-	C414
CF25	20	M4	N°6	-	C415
CF35/40	35	M6	N°6	-	C416
CF50	35	M6	N°6	-	C417
CF63	50	M8	N°8	-	C418
CF75	50	M8	N°8	-	C419
CF100	55	M8	N°16	-	C420
CF150	55	M8	N°20	-	C421
CF175	55	M8	N°20	-	C422
CF200	60	M8	N°24	-	C423
CF250	60	M10	N°32	-	C424
CF275	65	M10	N°30	-	C425
CF300	65	M10	N°30	-	C426
CF350	65	M10	N°30	-	C427

## VITON® CF aluminium centering ring



DN - KF	A	B	C	D	CODE
CF63	63	-	-	-	C428
CF100	100	-	-	-	C429
CF150	150	-	-	-	C430
CF200	200	-	-	-	C431
CF250	250	-	-	-	C432

# CF COMPONENTS

## Aisi 304 CF flexible

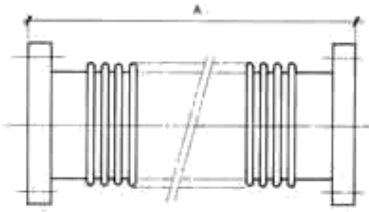

DN - KF	A	B	C	D	CODE
CF16	250	-	-	-	C433
CF16	500	-	-	-	C434
CF16	1000	-	-	-	C435
CF38	250	-	-	-	C436
CF38	500	-	-	-	C437
CF38	1000	-	-	-	C438
CF63	250	-	-	-	C439
CF63	500	-	-	-	C440
CF63	1000	-	-	-	C441
CF100	250	-	-	-	C442
CF100	500	-	-	-	C443
CF100	1000	-	-	-	C444

## Aisi 304 CF angle junction

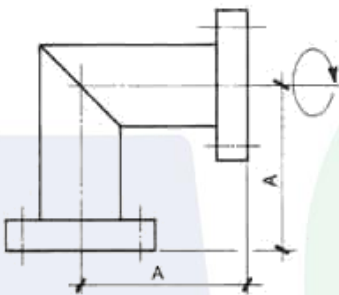

DN - KF	A	B	C	D	CODE
CF16	38	-	-	-	C445
CF38	63	-	-	-	C446
CF63	105	-	-	-	C447
CF100	135	-	-	-	C448
CF150	167	-	-	-	C449
CF200	210	-	-	-	C450

## Aisi 304 CF tee junction

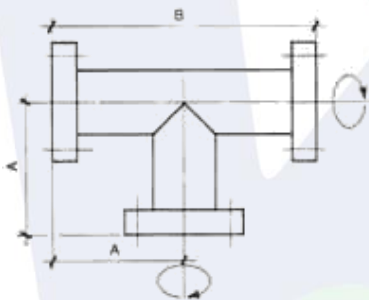

DN - KF	A	B	C	D	CODE
CF16	38	76	-	-	C451
CF38	63	126	-	-	C452
CF63	105	210	-	-	C453
CF100	135	270	-	-	C454
CF150	167	334	-	-	C455
CF200	210	420	-	-	C456

# CF COMPONENTS

## Aisi 304 cross junction

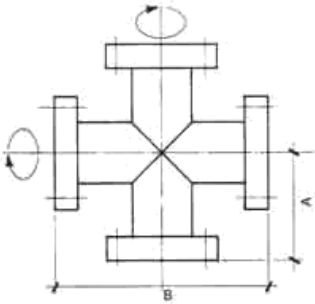

DN - KF	A	B	C	D	CODE
CF16	38	76	-	-	C457
CF38	63	126	-	-	C458
CF63	105	210	-	-	C459
CF100	135	270	-	-	C460
CF150	167	334	-	-	C461
CF200	210	420	-	-	C462

## Aisi 304 6-ways cross junction

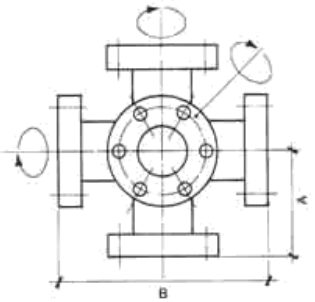

DN - KF	A	B	C	D	CODE
CF16	38	76	-	-	C463
CF38	63	126	-	-	C464
CF63	105	210	-	-	C465
CF100	135	270	-	-	C466
CF150	167	334	-	-	C467
CF200	210	420	-	-	C468

## PVC protection cap

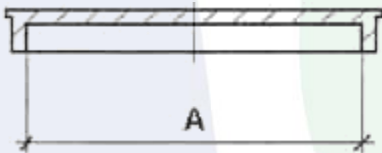

DN - KF	A	B	C	D	CODE
CF16	34	-	-	-	C469
CF25	54	-	-	-	C470
CF35/40	70	-	-	-	C471
CF50	85	-	-	-	C472
CF63	113	-	-	-	C473
CF75	117	-	-	-	C474
CF100	152	-	-	-	C475
CF150	202	-	-	-	C476
CF200	253	-	-	-	C477