

POMPA PER VUOTO AD ANELLO LIQUIDO

LIQUID RING
VACUUM PUMP

AL3610A

MODELLO AL3610A



La pompa per vuoto ad anello liquido modello AL3610A è del tipo monostadio con valvola, in esecuzione ad asse nudo. Compatta, versatile nelle prestazioni, raggiunge 180 mbar ass., adatta ad aspirare vapori e gas con tracce di liquidi, non necessita di lubrificazione, manutenzione contenuta. Disponibile in esecuzione standard o in acciaio inox. A scelta tenute a baderna o meccaniche.

The liquid ring vacuum pump model AL3610A is single stage type fitted with vary port valve, bareshaft version. Compact, flexible in performance, achieves 180 mbar abs., suitable to suck vapors and gas with liquid carry over, oil free operation, limited maintenance required. Available in standard version or in stainless steel. Option for gland packing or mechanical seals.

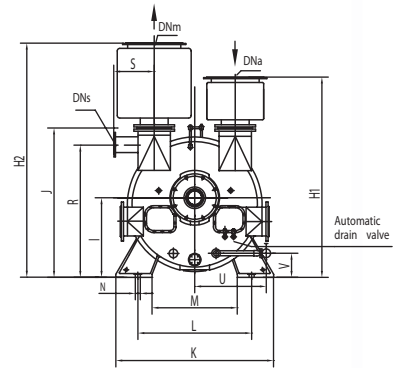
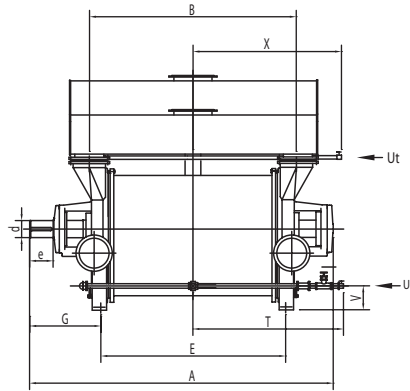

	A	B	E	G	H1	H2	K	I	J	L	M	N	R	S	T	U	V	X	Peso totale - Kg Total Weight - Kg
AL3610A	2980	2176	1950	640	2220	2560	1620	950	1770	1320	1105	ø 48	1550	370	365	1000	244	1550	8500

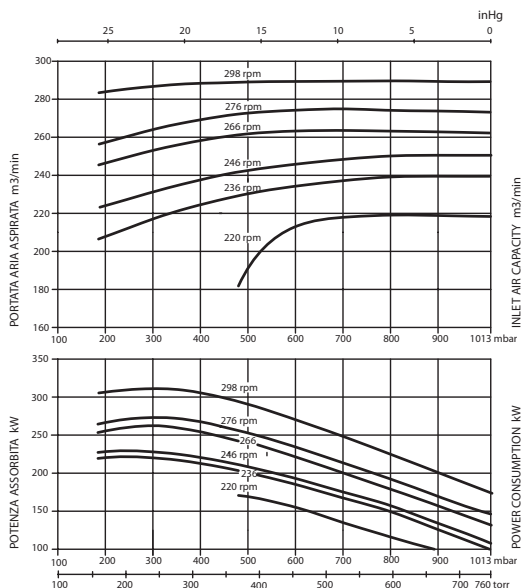

DNa	400 - 16"	Attacco aspirazione Suction nozzle
DNm	400 - 16"	Attacco mandata Discharge nozzle
DNs	200 - 8"	Attacco scarico Water discharge nozzle
Ub	G 3"	Attacco per liquido di esercizio Service liquid connection
Ut	G 1"	Attacco flussaggio esterno tenuta (se richiesto) External seal flushing (if requested)
d	180	Ø Albero - Shaft
e	240	Sporgenza d'albero - Shaft extention

I valori di portata sono riferiti ad aria saturata, alla temperatura di 20°C, alla pressione atmosferica di mandata (1013 mbar), e all'impiego di acqua alla temperatura di 15°C. Tolleranza di prestazione ± 10%. Nell'esecuzione in inox la portata diminuisce del 5%. I dati sopraindicati possono essere variati senza preavviso.

The given capacity values are referred to saturated air at the temperature of 20°C, atmospheric discharge pressure (1013 mbar), and of supply of service water at 15°C temperature. Performance tolerance ± 10%. Stainless steel construction is 5% less performing. The data may change without any notice.



TECNOLOGIA DEL VUOTO
Vuoto Service S.r.l.
Via Filippo Meda, 16
20037 Paderno Dugnano (MI)
Tel. 039 02 99 044 533
Fax 039 02 91 055 03
www.vuotoservice.net

a i r m o v i n g